

Guide eFlex Q20 loading for Optima 8 array system

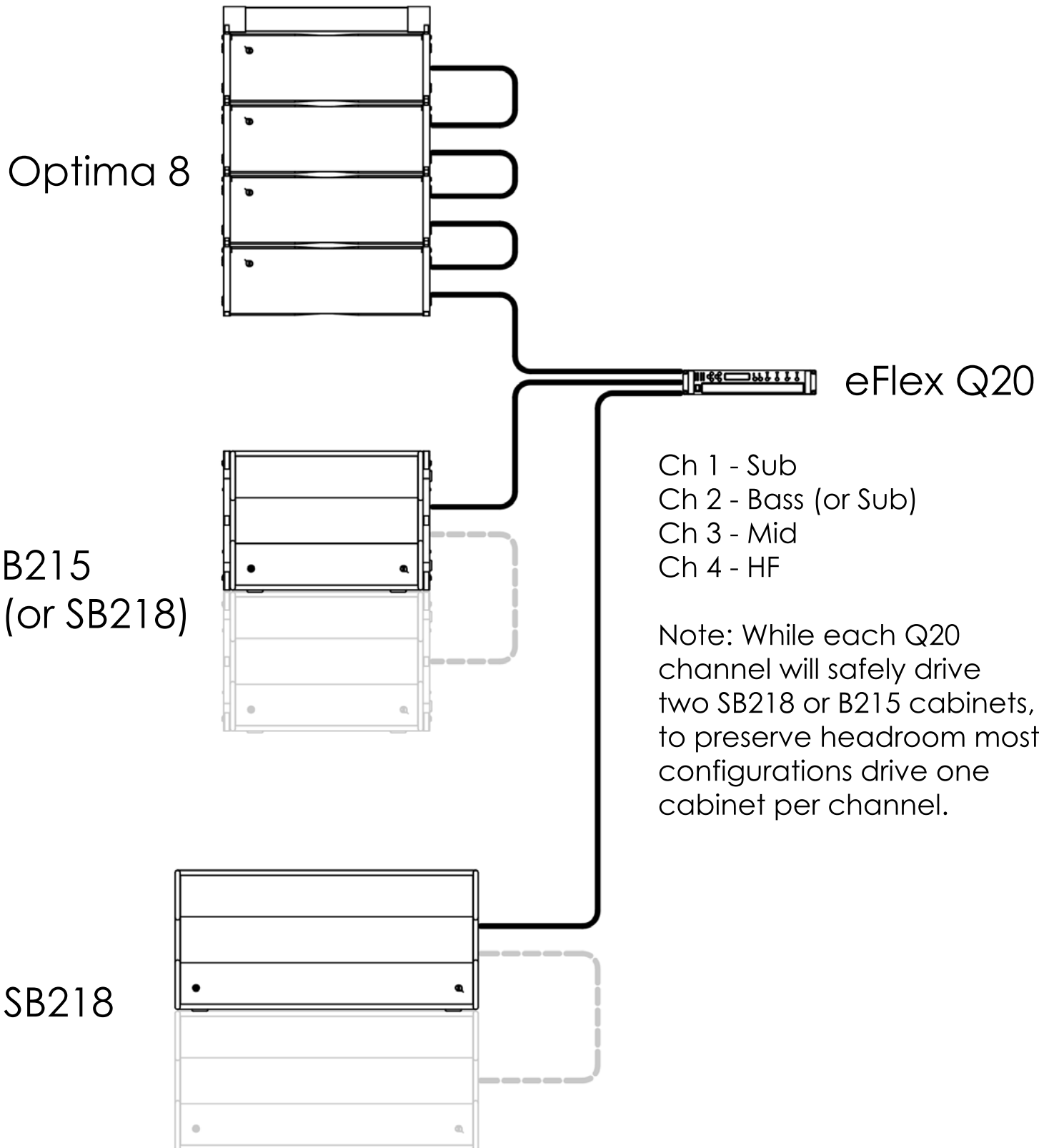

Groundstack configurations: 3 stack

Optima 8

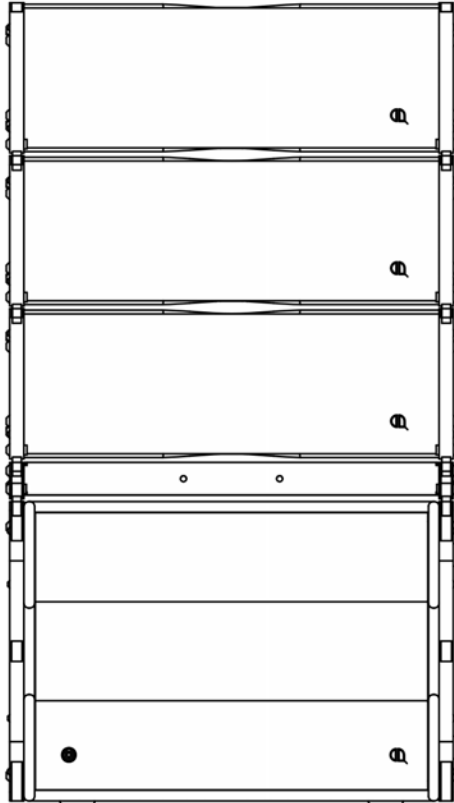

B215

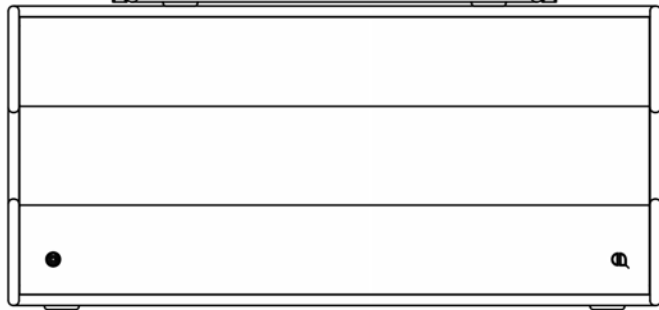

SB218

Flex Rack 2

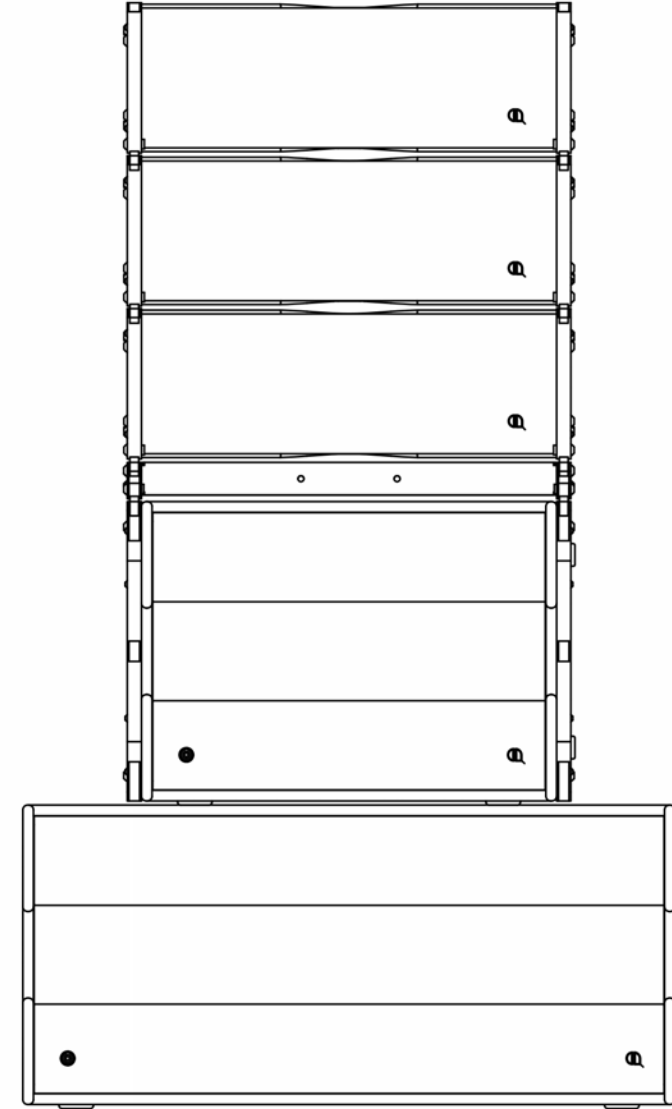
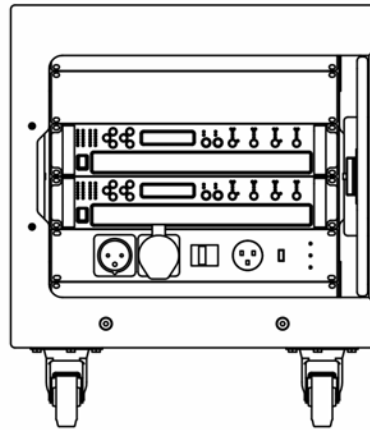

Groundstack configurations: 4 stack

Optima 8

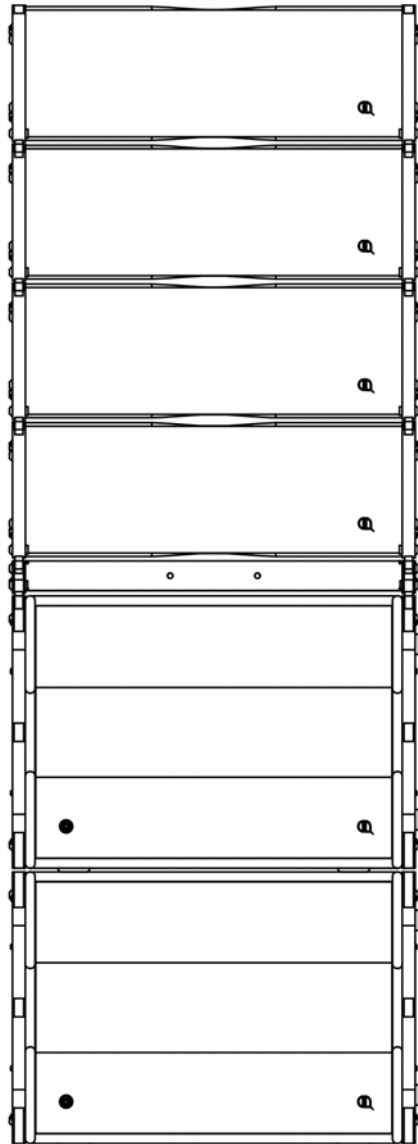

B215

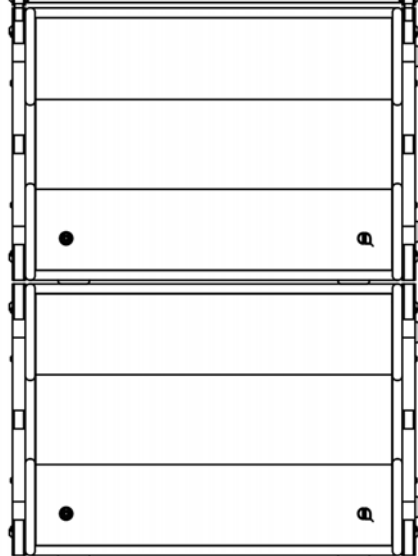

SB218

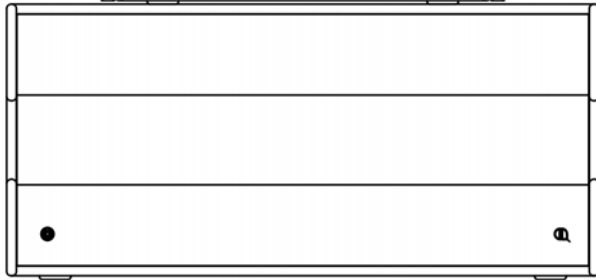

Flex Rack 2

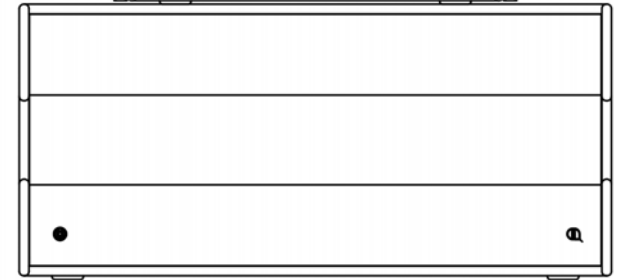
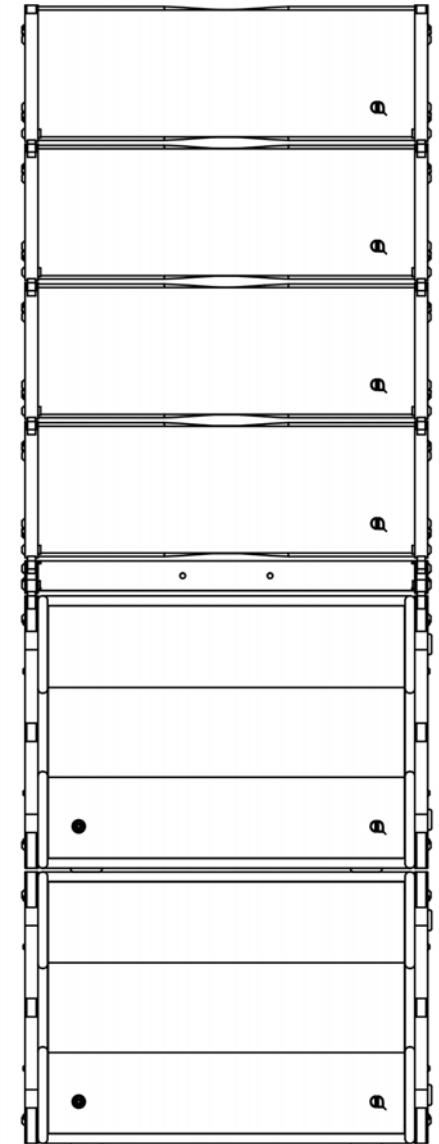
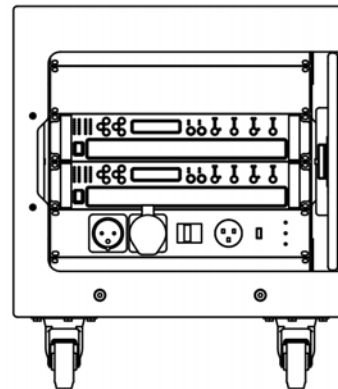

3 way flown array: 8 hang

B215

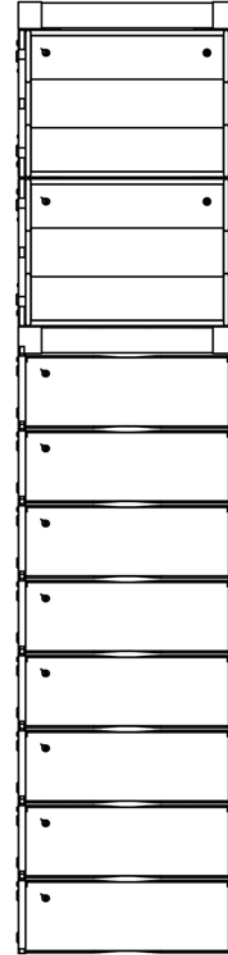

Optima 8

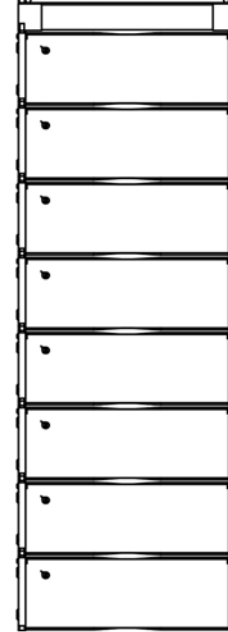
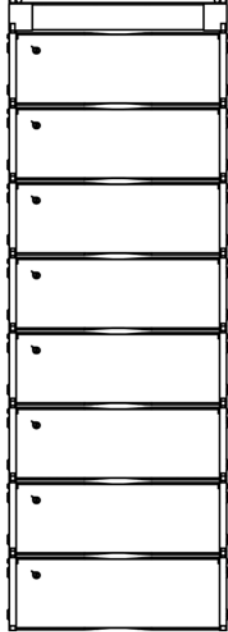

SB218

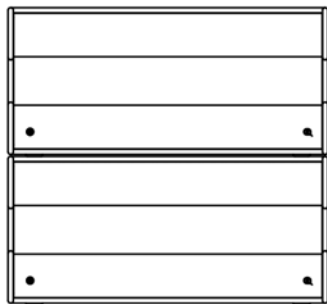

Flex Rack 2

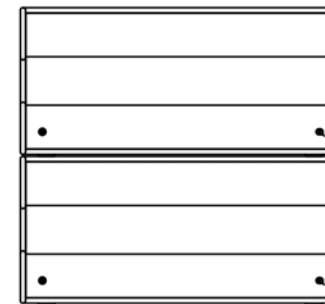
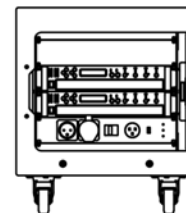
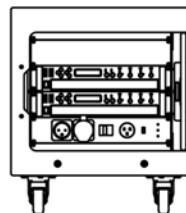

3 way flown array: 12 hang

B215

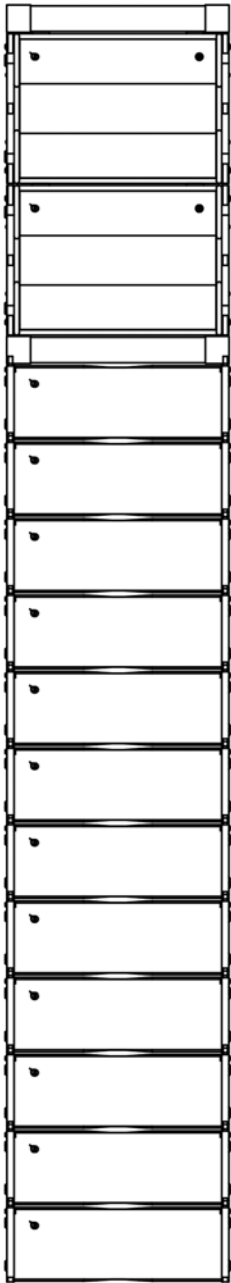

Optima 8

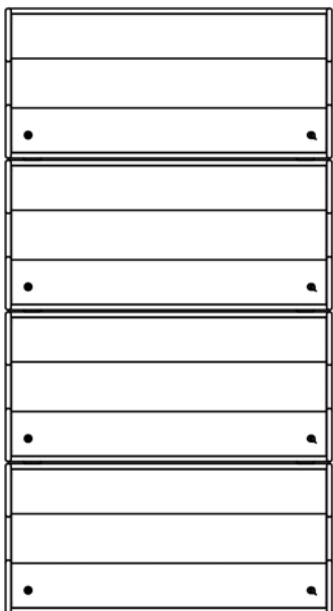

Flex Rack 3

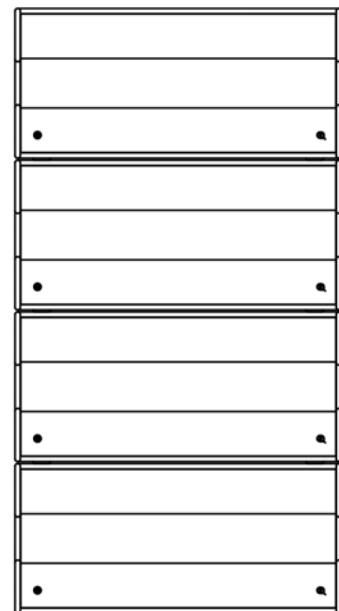
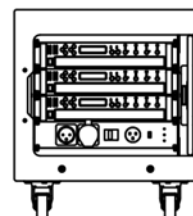
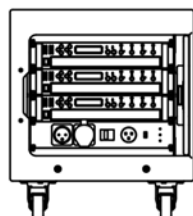

2 way flown array: 8 hang

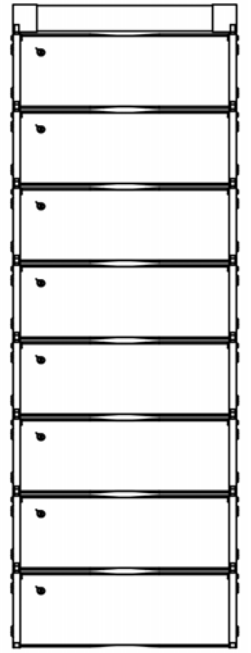
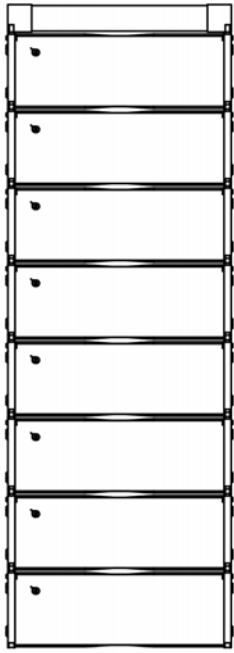

Optima 8

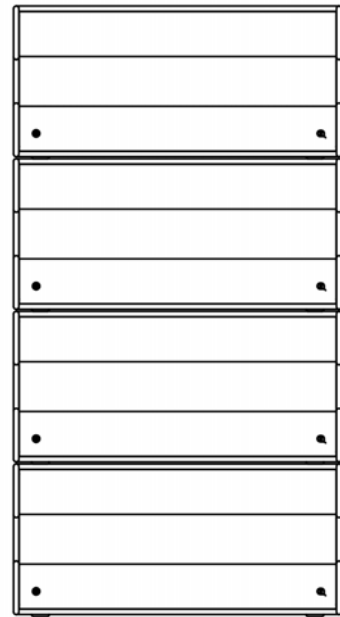
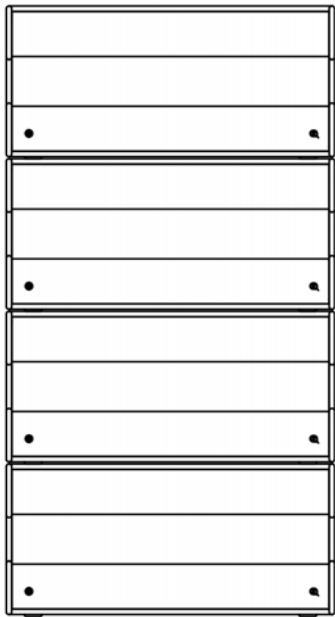

SB218

Flex Rack 2

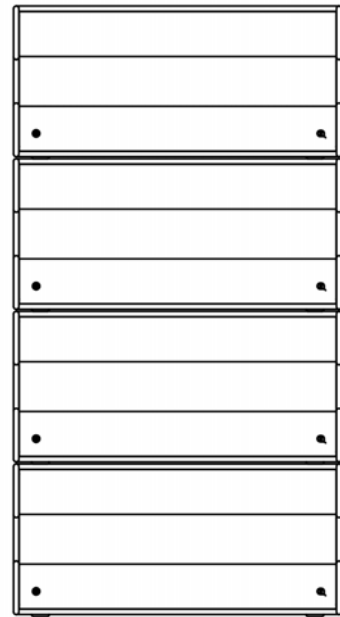
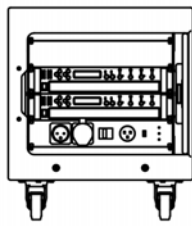
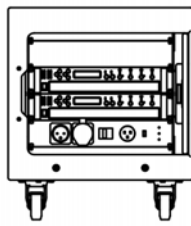

2 way flown array: 12 hang

Optima 8



SB218

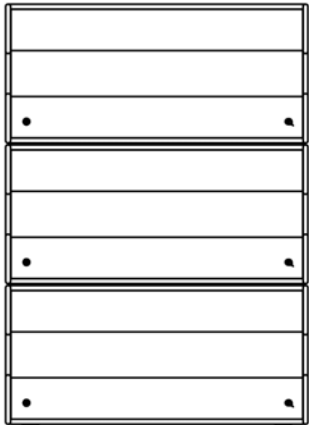
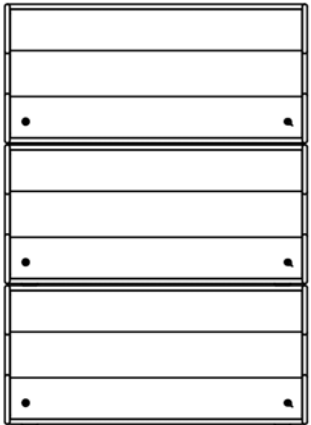

Flex Rack 3

